

**OLYMPUS**<sup>®</sup>

Your Vision, Our Future

Digital Microscope

---

**DSX110**

---

Discover Another Dimension



# For All Conventional Microscope Users, This Is an Olympus Proposal for the Next Generation of Microscopes.

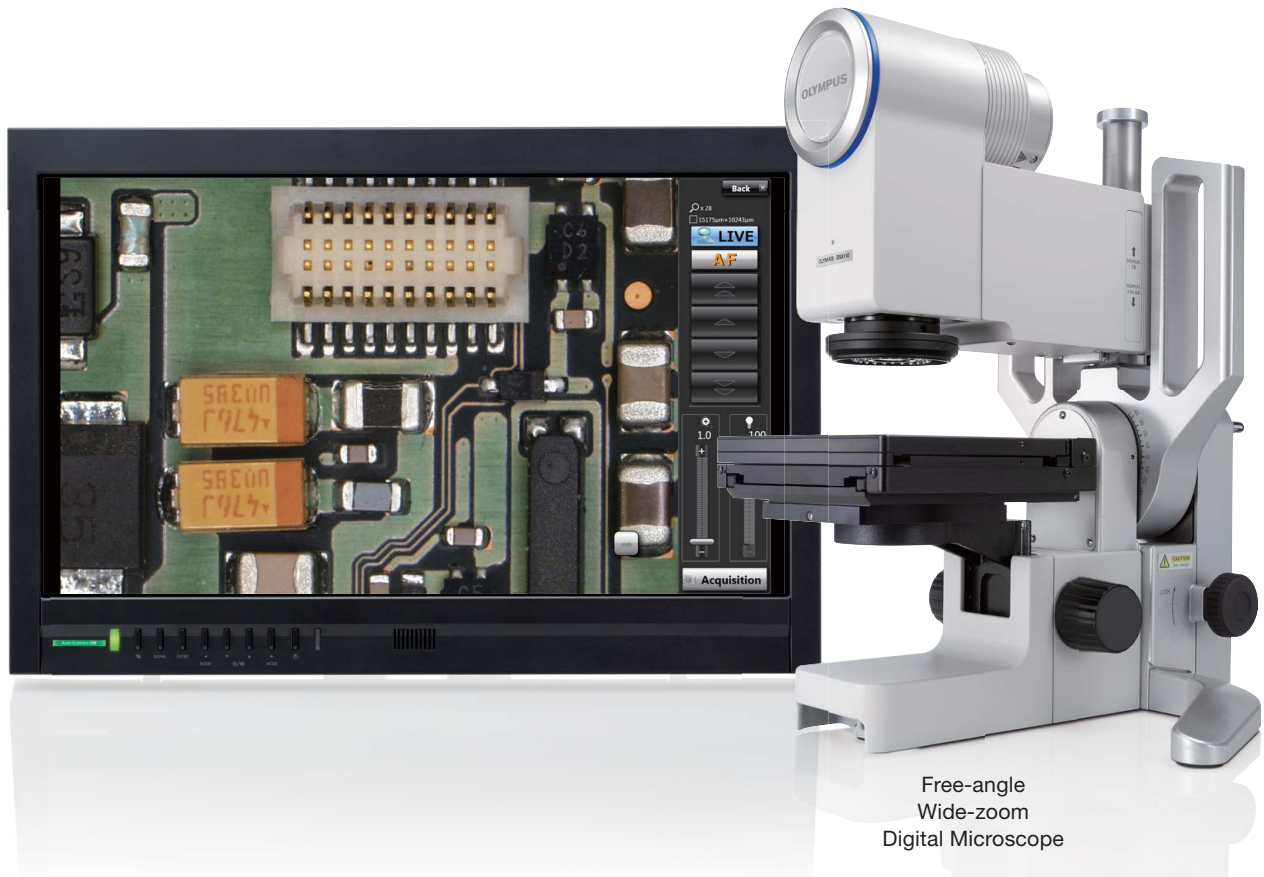

Olympus introduced the world to a new dimension in industrial microscopy with the DSX Series digital microscope system. Today, with the unique combination of time-tested Olympus optics and today's newest digital imaging technology, the Olympus DSX Series sets a new standard in industrial microscopes. The Olympus DSX Series digital microscopes allow even first-time users to immediately produce superior images and highly reliable results, thanks to even more advanced features and an even simpler interface. No matter how big the challenge, DSX delivers the solution.

## The DSX110 Provides Observation, Image Capturing, Measurement, and Sharing — All in One.

### Efficient Observation

---

Thanks to higher-quality optics and more advanced digital technology, the DSX110 delivers more efficient observation, more intuitive magnifying operation, a variety of observation methods, and easy reproducibility. Furthermore, its free angle function allows examination of samples from any angle, with a precise 16X optical zoom range.

### Easy Image Capturing

---

Various image capturing methods provide easy, intuitive operation — as simple as using a smartphone or tablet. Options include EFI and 3D imaging, wide area image capturing, movie capturing, and programmed image capturing.

### Various Measurement Tools

---

Easy-to-use measurement tools enable both 2D and 3D measurement as well as advanced particle analysis. A simple wizard function provides measurement automation.

### Easy Sharing

---

A well-designed reporting system allows easy sharing of measurement and analysis results. Reports can be created with one click, then exported to a variety of formats.

# Efficient Observation

More to See. Easier to Use.

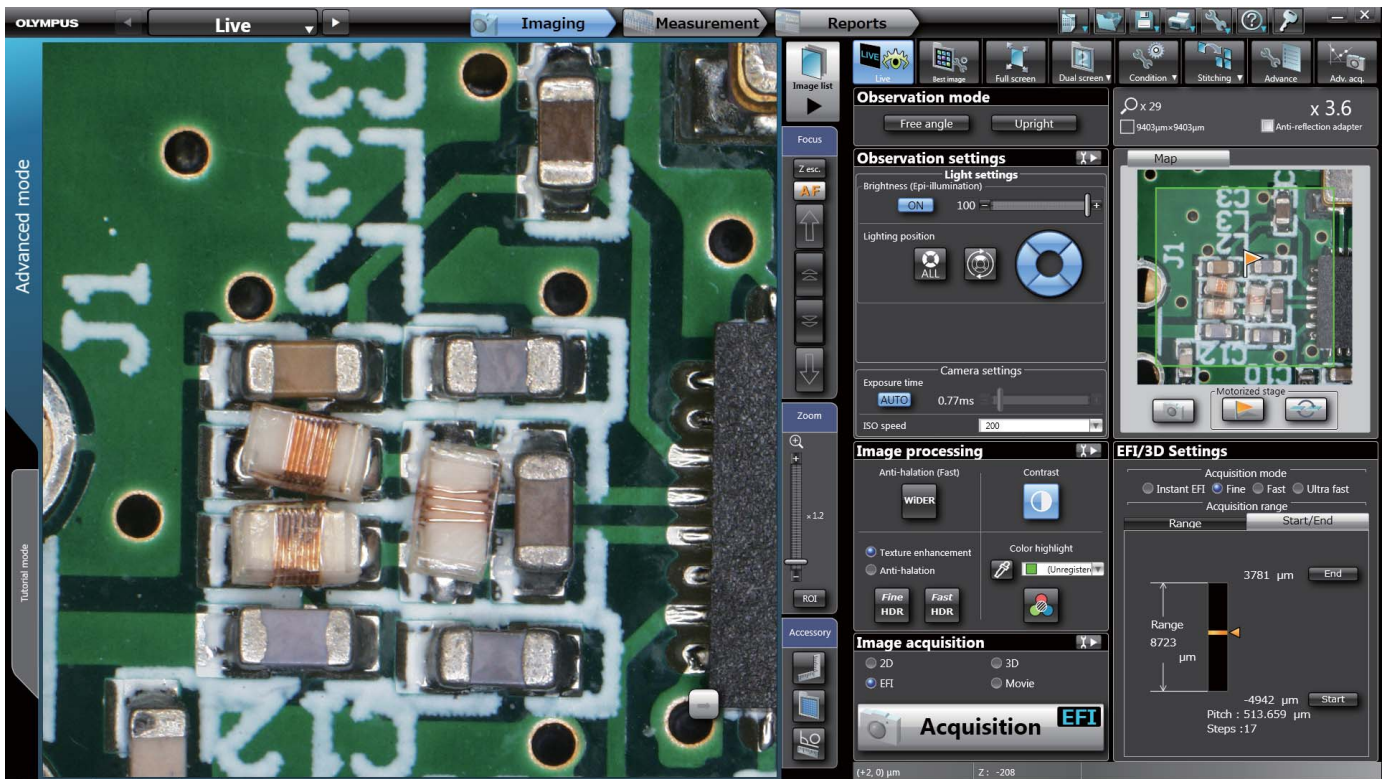

Made possible by the unique combination of optics and today's newest digital imaging technology, the DSX110 digital microscope is the culmination of a long history of superior engineering, design, and manufacturing. The microscope minimizes glare, delivers accurate color reproduction, and eliminates flare and distortion. Every sample is reproduced with such accuracy that it's simply stunning, and stunningly simple. Take a closer look at the DSX110, and see what other digital microscopes cannot.



# Technology that Reveals What Couldn't Be Seen Before

## Dedicated Field Lenses Make High-Grade Imaging Simple

Manufactured specifically for the DSX110, dedicated 1X, 3.6X, and 10X lenses combine high NA, long working distances, well-controlled aberration, and evenness of light intensity like never before. DSX110 dedicated lenses deliver the longest working distance in their class. Each lens has embedded LEDs designed to achieve optimal illumination from any angle.



## LED Illumination: Picture-Perfect Inspection, Reduced Energy

The advanced LED illumination of DSX110 not only ensures accurate observation, but also helps reduce operating costs. Most importantly, color does not change with the LED's intensity, minimizing the need for white balancing. Long LED working life makes the instruments virtually maintenance-free.

## High-Resolution 18MP Images Reproduced with High-Performance CCD\*

Olympus's high-performance CCD is the engine that shows exactly what our high-quality optics reveal. Our image shift function ensures high fidelity with fine detail processing, so clarity extends from corner to corner. Features include a Full HD camera and HDR digital processing.

\*4800 x 3600 pixels. 3CCD mode conversion triples pixel count.

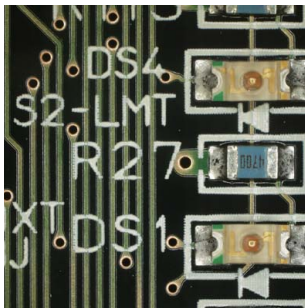

Mounted substrate

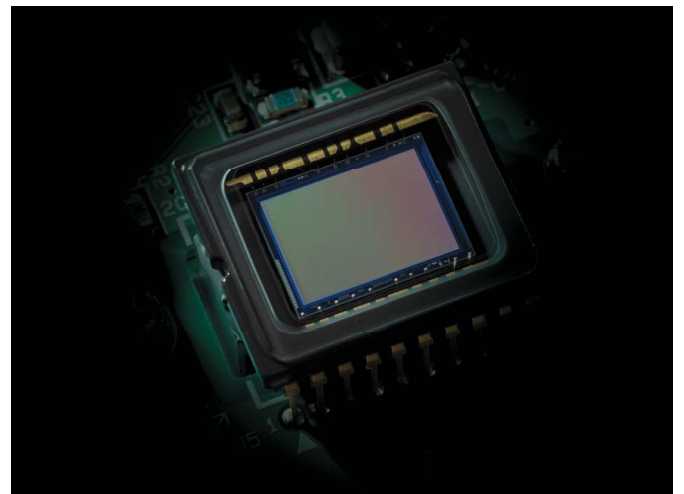

High-performance CCD



Fractured metal surface



\*Observation with HDR image processing

# Zoom Optics and Free-Angle Observation

## Wide Zoom and Magnification Range: Get Closer to the Sample

Change the magnification to fit individual needs — the DSX110 provides an optical zoom up to 16X and a digital zoom up to 30X. The DSX110 also offers a wide magnification range, with a 16X wide zoom range, and a total magnification of 7X to 1071X (with dedicated 10X lens).

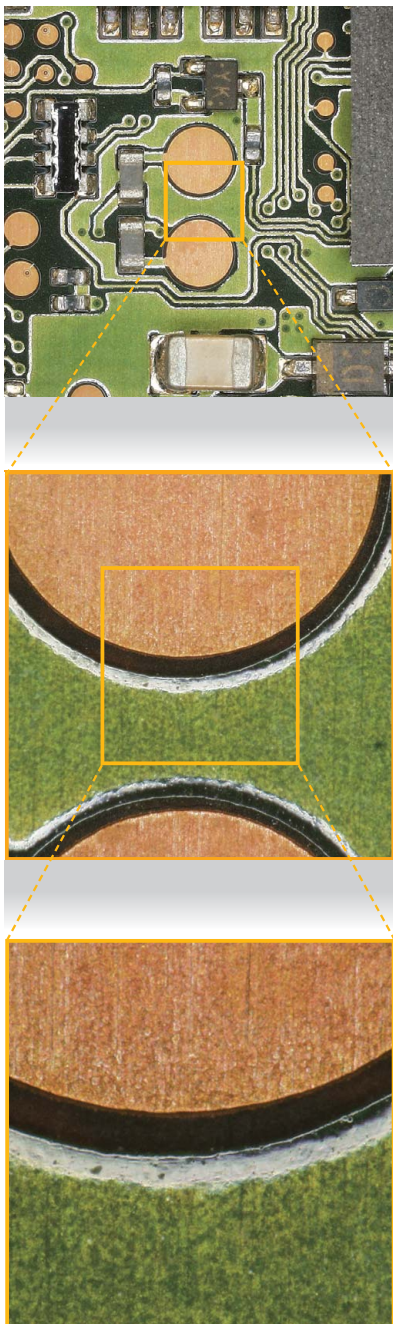

Zoom in on the sample

## Macro Map: Always Know the Location

As zoom magnification is adjusted to a higher level, the area that can be seen at one time is reduced — Macro map automatically records a full field of view image in a separate macro window. On this full field image, specific location on the sample is noted and updated as the sample is moved. If using the panorama function, it will also be displayed in a macro window to provide the same convenience on an even larger area.

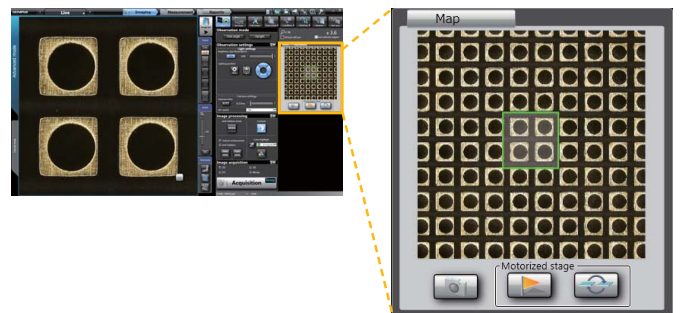

Macro map:  
Always know the location

## Free-Angle Function: Angled Viewing with No Need to Touch the Sample

With conventional microscopes such as metallurgical microscopes, the sample needs to be moved in order to observe it from an angle, and the microscope often needs to be refocused. With the free-angle function of DSX110, merely tilt the zoom head to change the viewing angle without touching the sample. A sturdy frame with a low center of gravity provides extra stability when tilting the head.

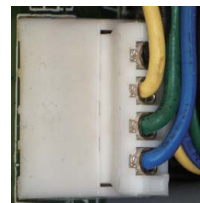

Left 45 degrees



Directly above



Right 45 degrees





# A Variety of Observation Methods

## Flexible LED Ring Light Makes Scratches and Defects Easy to See

The LED ring light of DSX110 is divided into four segments that allow flexible illumination control, making scratches and defects easy to find and identify.

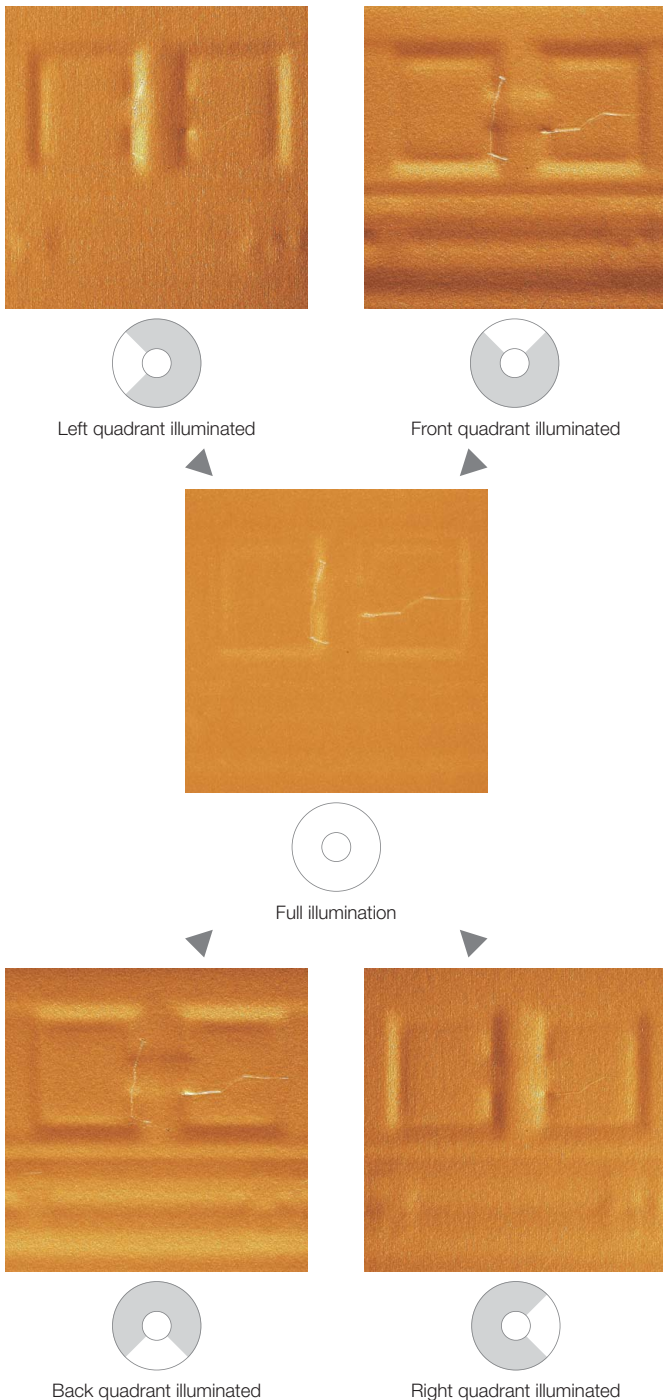

## Polarized Lighting Controls LED Unit Reflection

When observing highly reflective samples, the polarized lighting of DSX110 controls reflection of the LED illumination ring, ensuring clear observation. Adapters for each objective lens (1X, 3.6X) are available.

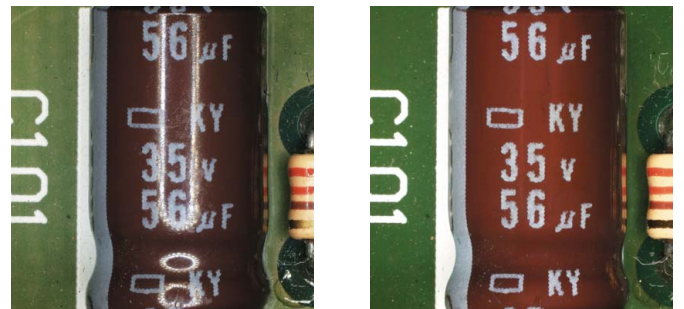

Without polarized lighting

With polarized lighting

## Flexible Configuration Allows Maximum Performance

Designed to deliver operational flexibility coupled with superior performance, the DSX110 features a transmitted illumination base and a universal stand designed to accommodate larger-sized samples.



# Advanced Image Processing

## HDR: High-Definition Visuals Beyond the Human Eye

Sample appearance can vary depending on quality of material, surface conditions, or illumination methods. One of a variety of observation methods made possible by the advanced digital technology of DSX110, the HDR (High Dynamic Range) function, combines several images taken at different exposures to accurately correct brightness differences on the sample surface, delivering a more consistently accurate sample rendition. HDR provides high-fidelity images that show not only textures but also flaws and defects that were previously undetectable. Glare can also be reduced for more comfortable observation.

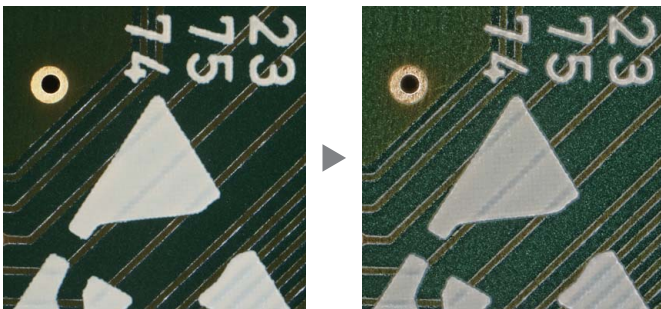

Printed circuit board (Normal)

(HDR)

## Option

---

### Fast HDR Mode

With a higher refresh rate than normal HDR, Fast HDR provides smooth imaging even when moving the stage or focusing the sample.

### Fine HDR Mode

Fine HDR delivers better image quality with less noise. This is achieved by gathering more data than standard HDR.

## WiDER: Easy Inspection of Samples with High Reflectance Difference

If a non-reflective image area cannot be seen, merely increasing illumination power is often not enough, as glare can occur. The DSX110 eliminates this issue with WiDER, a proprietary image processing system that takes care of high-contrast problems with one click. No blackouts. No glare.

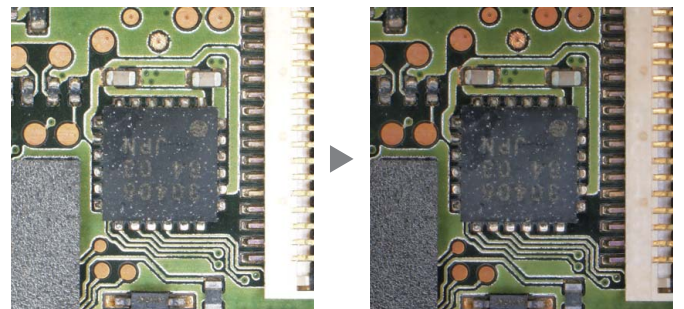

A click removes problems caused by different contrast by materials

## Color Enhancement: See Only What's Required

The color enhancement feature of DSX110 allows color to be placed where it is needed while leaving the rest of the image in black and white, making it much easier to locate defects. Ideal for focusing on one particular defect.

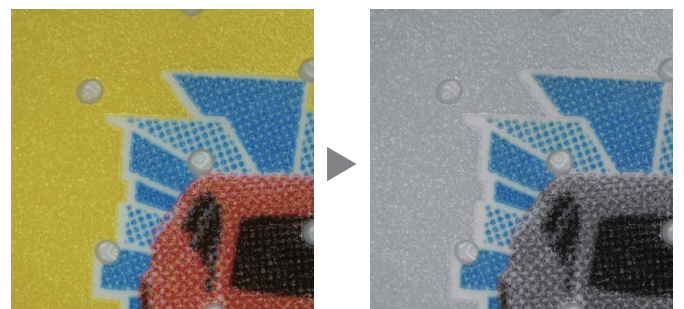

Inspection is easier when you can highlight possible defects or contamination for inspection



# Anyone Can Make Observations in Optimum Conditions

## Best Image Function Ensures Optimal Performance from Any Operator

Operate the system by simply choosing the image that works best — the DSX110 will set all the necessary parameters to achieve that image. The Best image function ensures optimal images, whether looking for defects, uneven surfaces, or foreign objects. With Best image, anyone can operate the system — beginner to expert — and it can be customized for each operator.

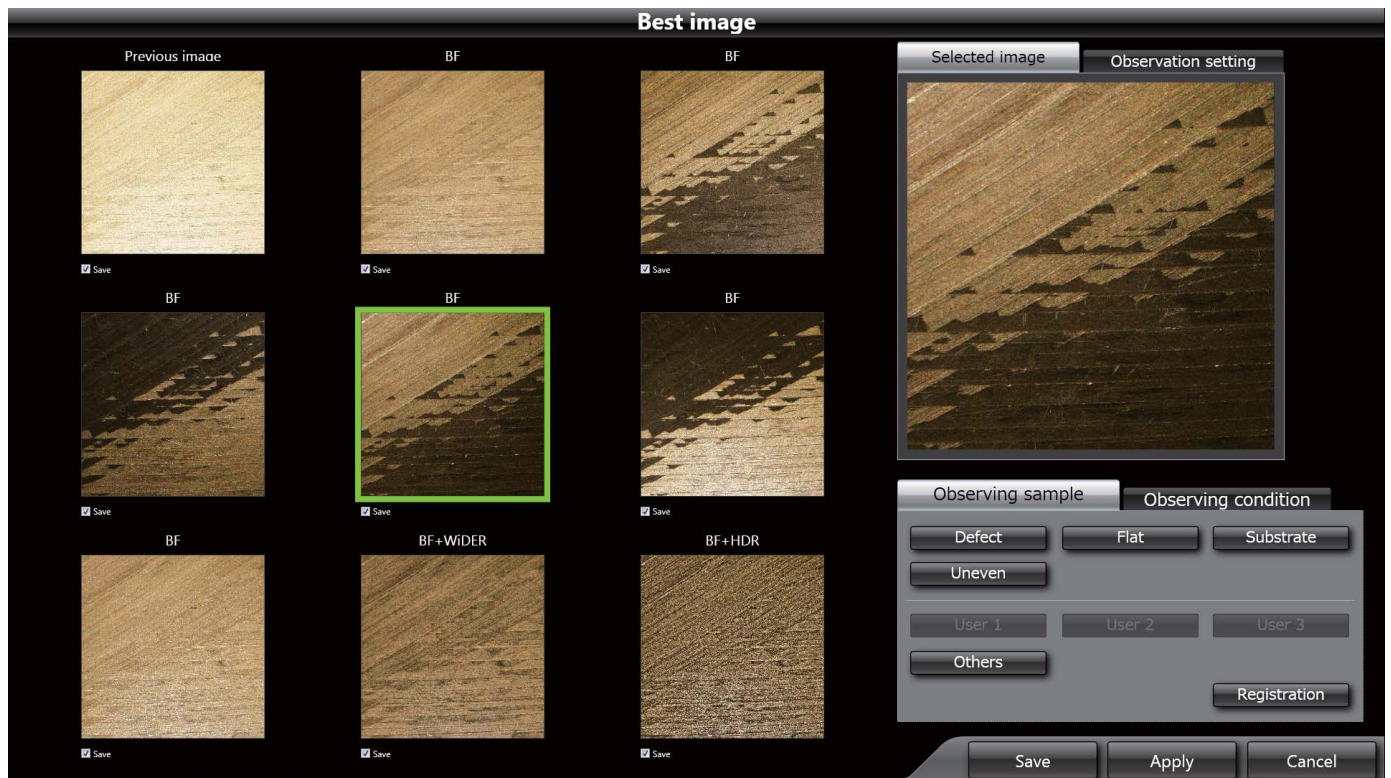

Best image

## Repeatability: Easily Recall Any Inspection (Observation) Setting

The mechanisms of DSX110 are fully digitalized so that every image taken or saved has the conditions it was taken under recorded with the image. If an image is captured with the DSX110, the operator can retrieve the conditions of capture from the image data with one click, enabling additional observations under the same conditions and settings.



## Image Capturing Has Never Been More Intuitive. Or More Informative.

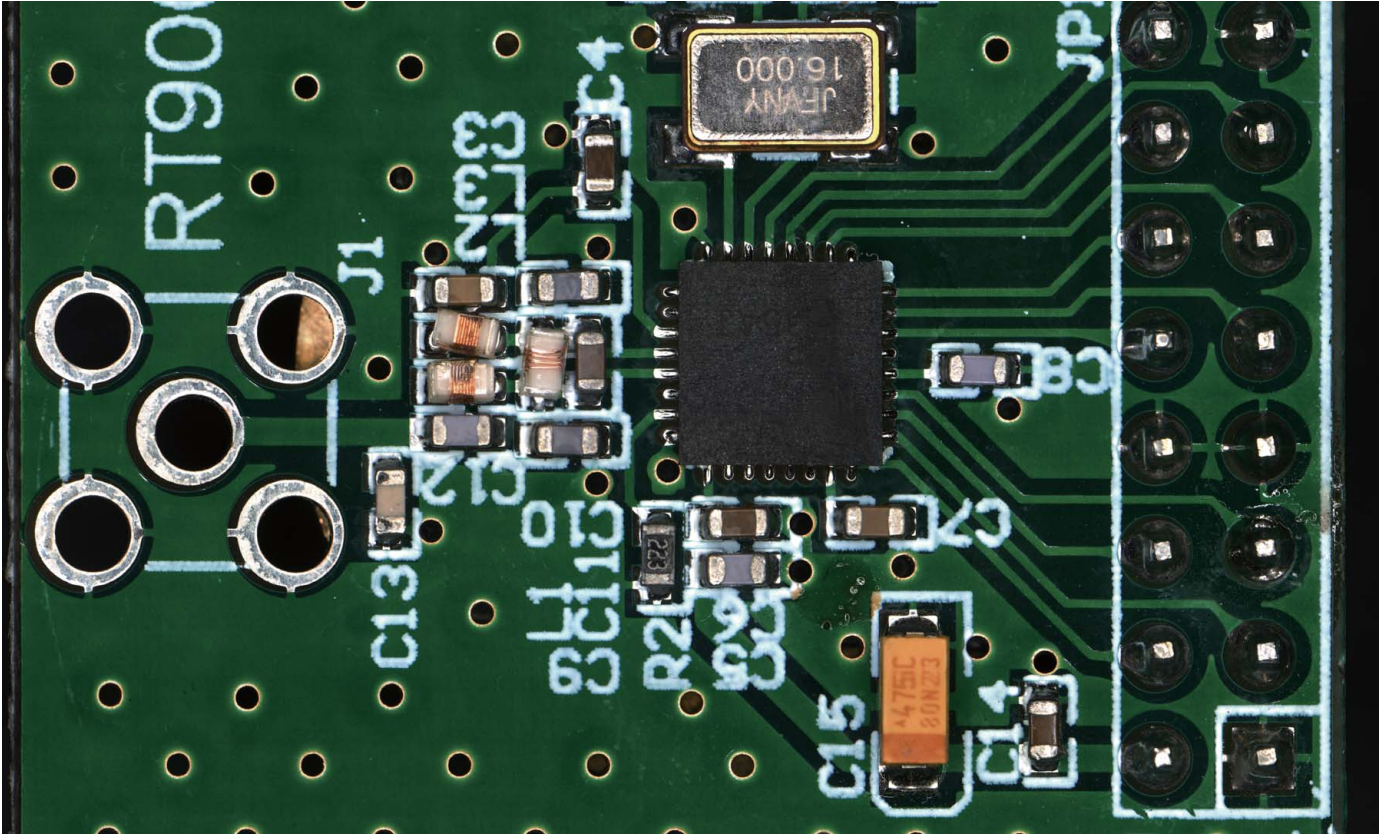

A variety of convenient image capturing methods. Extremely intuitive operation. Quick, easy access to the sample information observers need most. Ideal for users of all skill levels, the DSX110 does not require extensive microscope experience to capture and utilize images that precisely suit the requirements. In the past, only experts with years of experience could adjust microscopes in a way that allowed the capture of optimal images. Today, the DSX110 enables any operator to do so with an easy-use interface and advanced image capture technology — in a few simple steps, the ideal image for inspection or analysis is attained. Reveal what couldn't be seen before. Realize what couldn't be created before. Achieve more than previously thought possible.



# Capture Full-Focus Images or 3D Images

## EFI: View Uneven Samples in Focus Across the Entire Image

With its EFI (Extended Focal Image) capability, the DSX110 can obtain a clear, in-focus image of an entire sample with one click — no matter how uneven the surface. During EFI, several images are taken while the point of focus is moved up and down. From these images, the areas where the sample was in focus are combined into one image where the whole sample is in focus, allowing precise inspection of uneven surfaces. Olympus's EFI capturing speed is now faster than ever.

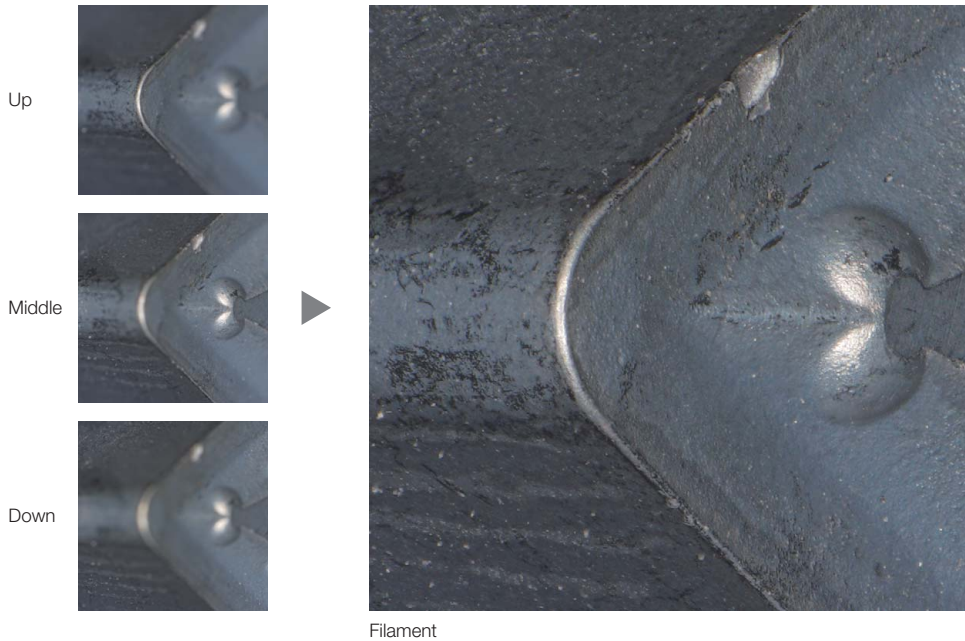

## 3D Image: One Click Shows the Sample in 3D

With one click, the DSX110 can capture image samples in three dimensions, allowing examination from any angle and a view of the sample as it actually is. With detailed 3D images, sample features or unevenness can be viewed and measured. Height differences and volume can also be measured, making it easier to accurately analyze the sample. 3D imaging is simple and fast, with improved capturing speed.

\*Requires 3.6X or 10x objective lens for 3D image capturing

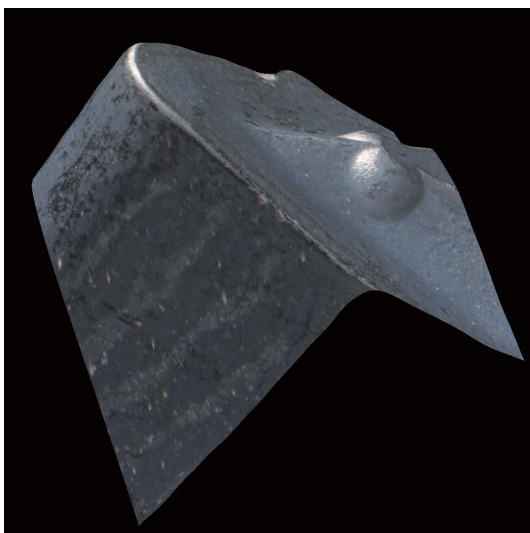

3D images

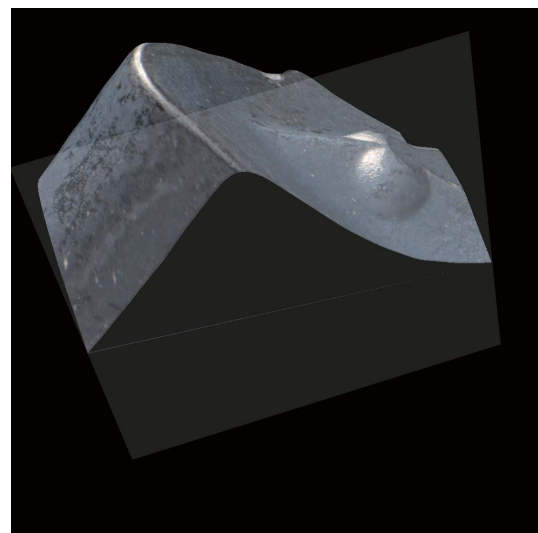

Cutaway view



# Live Panorama Capturing Covers Large Areas Fast

## Live Panorama

There is no longer such a problem as “outside the field of view.” With Live panorama, simply move the observation position on the screen, and the motorized stage will move the sample to that position. As the stage moves, the system automatically stitches images into a large single field of view, in real time.

### Auto Panorama: One click captures a large field of view

Simply put the sample on the stage, and start the process with one click. The stage moves in a spiral and the feature captures the required area automatically. Detailed calibration is not necessary, so anyone can obtain a wide angle of view through easy operation.

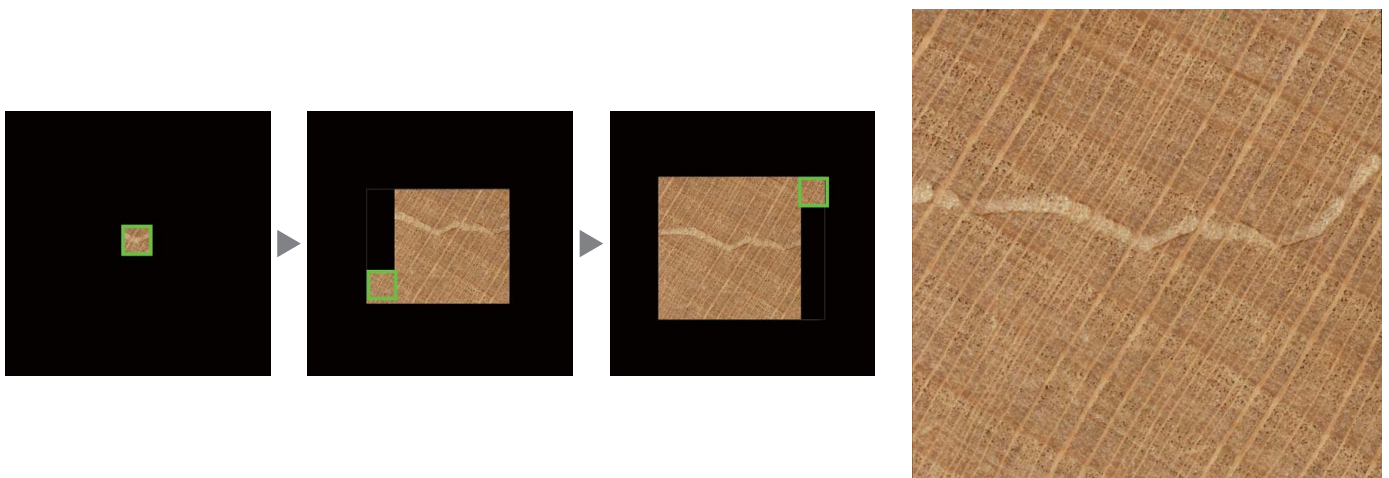

### Manual Panorama: Prioritize a required area

Obtains real-time image stitching of the desired area in a very short time, by moving the stage vertically, laterally and obliquely.



# Automatic Stitching Gives High-Quality, High Value-Added Image

## High Quality Panorama

Set the number of images, the length, and the starting point, then start the image stitching process. This executes pattern matching and corrects shading, resulting in a high-quality and high value-added image.

**High quality panorama**

- Number of pieces
- Length
- Start/End positions

Horizontal	<input type="text" value="50"/>	pieces	84.815	mm
Vertical	<input type="text" value="20"/>	pieces	34.039	mm
Alignment	<input type="text" value="Center"/>	Unit	<input type="text" value="mm"/>	
		Overlap	<input type="text" value="10%"/>	

## Improved Algorithms for Pattern Matching and Shading Correction

Wide angle, high-resolution and high-quality images are realized with optimized pattern matching and no misalignment.

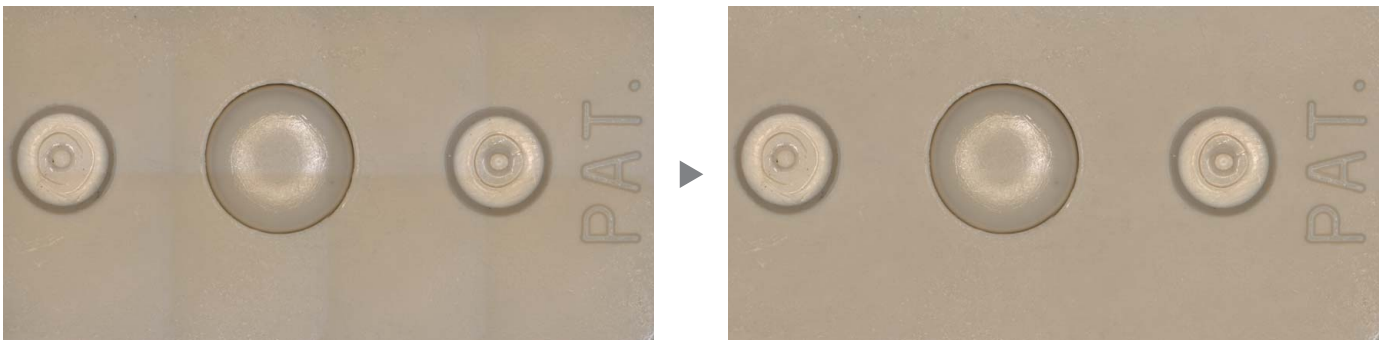

## EFI and 3D Image Capturing

High quality panorama capability can be coordinated with EFI and 3D image capturing as well. The ability to capture images across a wide area, show uneven surfaces in full focus, and produce 3D images means the data exceeds that of ordinary digital microscopes.

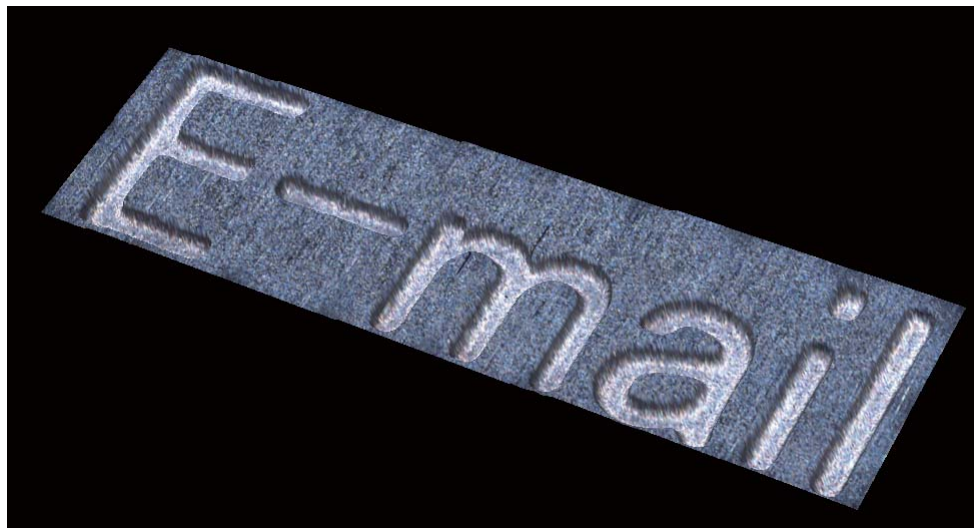

# Large Amounts of Data Automatically Captured

## Programmed Recipes: Automatically Capture Independent Points

Through a convenient programmed recipe function, the DSX110 can automatically capture images of several registered points using its autofocus function.



Motorized stage with 100 mm x 100 mm stroke

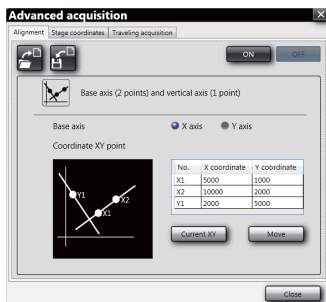

Alignment

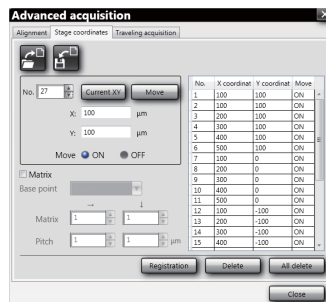

Stage coordinates

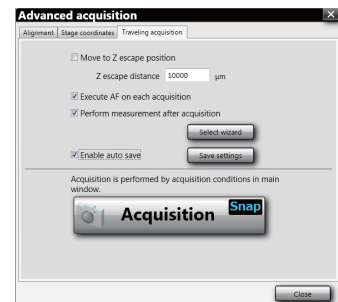

Traveling acquisition

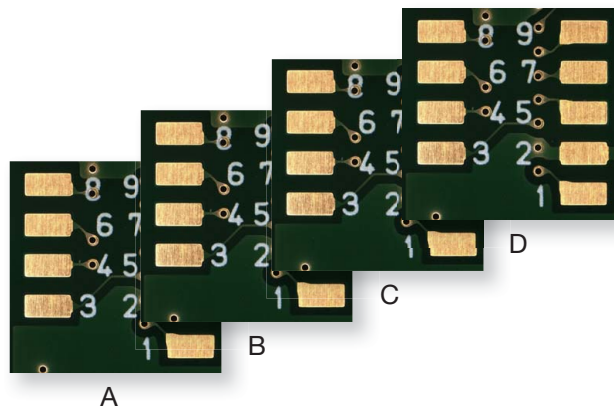
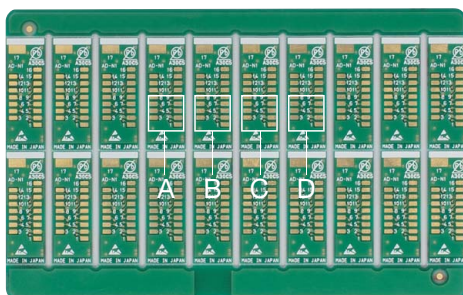



# Convenient Functions Support Image Capturing

## Annotation

After capturing an image, annotations of important information and graphics can be saved with it. As position and explanation of defects can be saved and shown, this feature is excellent for sharing data with other people concerned.

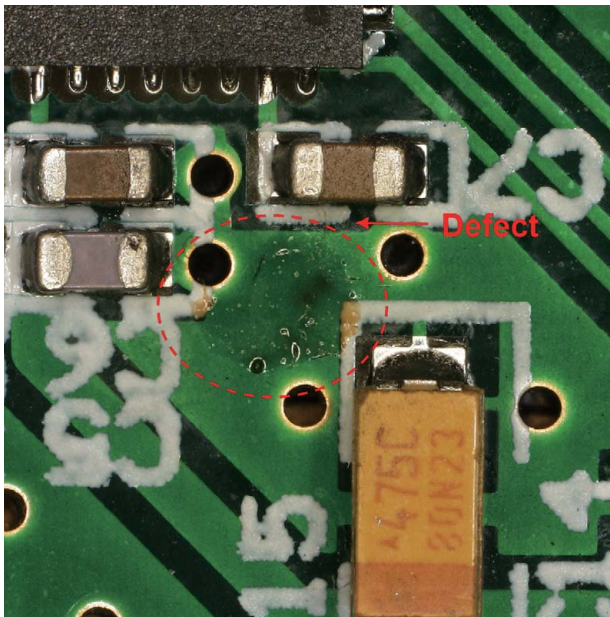

## Automatic Save Function

Any image captured can be automatically saved to the folder indicated. In addition to file name and number, it is possible to expand the image as well.

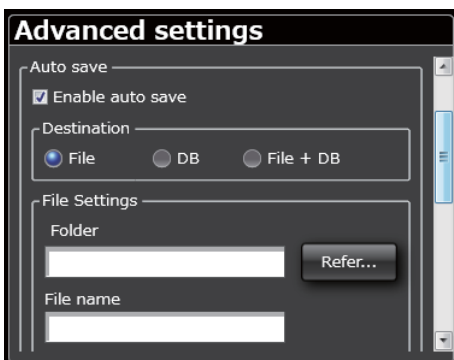

## Video Capturing

If a sample changes over time, the changes observed during live observation can be captured as video images. (file type: .avi)

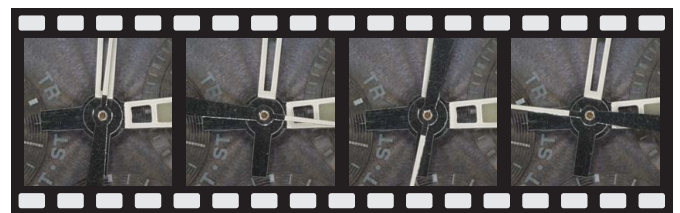

# Various Measurement Tools

## Unmatched Versatility and Flexibility

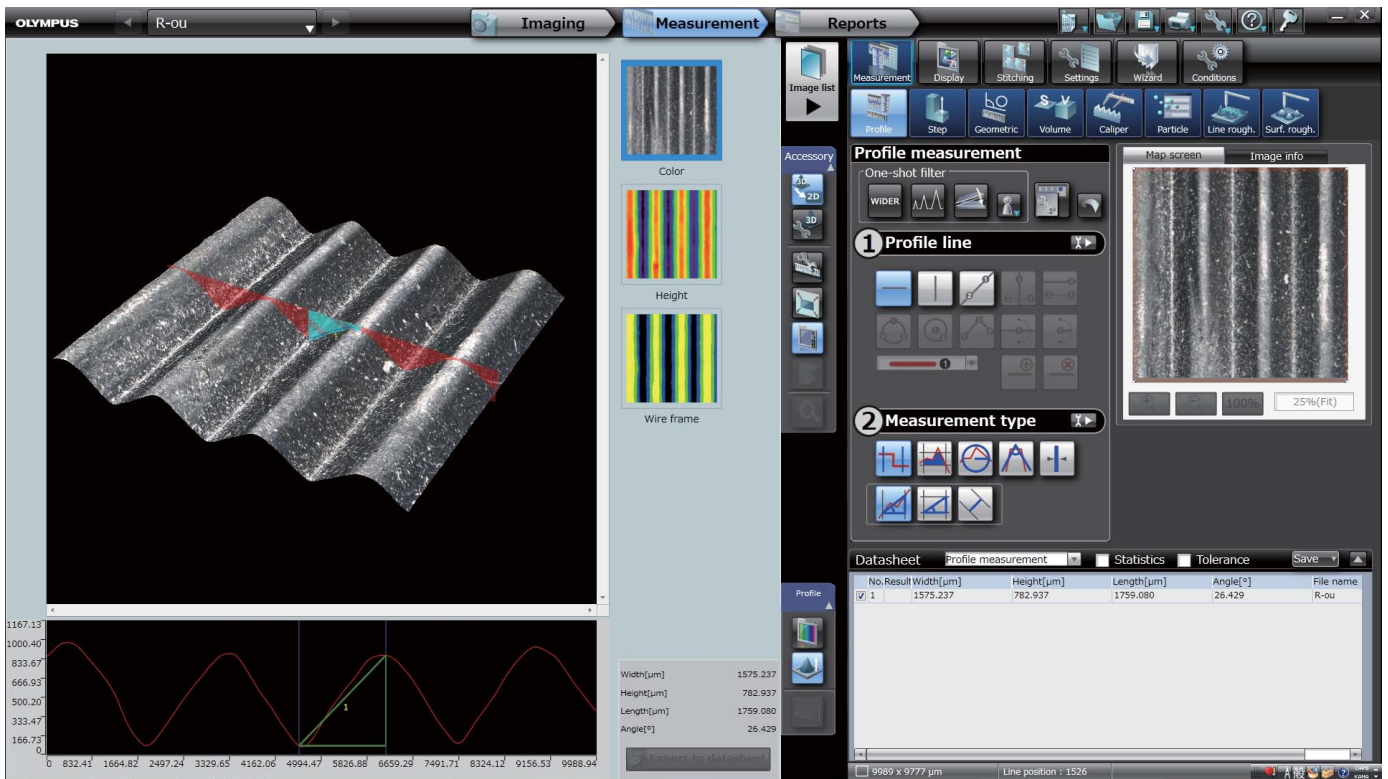

The DSX110 provides various easy-to-use measurement tools that enable 2D and 3D measurement as well as advanced particle analysis. Additionally, it allows you to evaluate your samples quantitatively to reinforce your development and inspection operations.

# Ample Measurement Functions

## Features that Ensure Optimal Measurement Results

All fundamental industrial microscope measurement capabilities are standard features of DSX110 software, making it easy to obtain optimal measurement results. Optional software is available for 3D measurement, caliper measurement, and particle analysis.

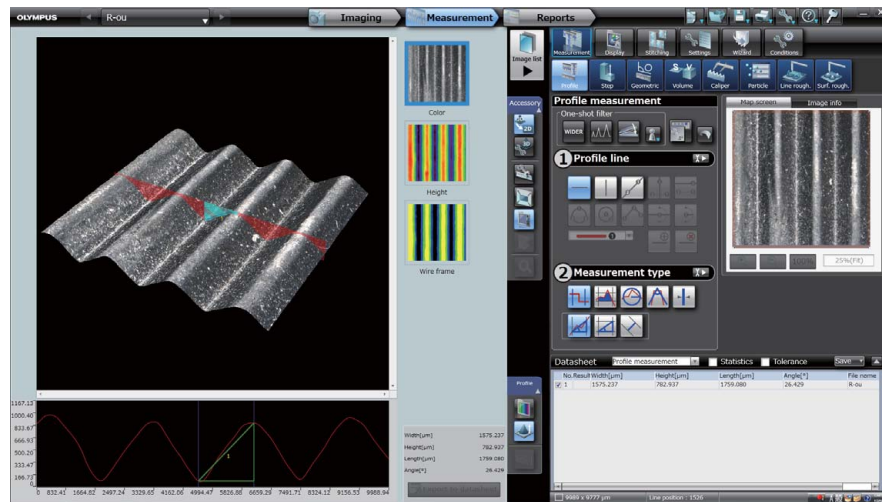

Profile 3D measurement

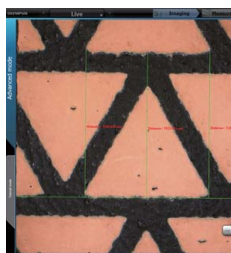

Live measurement

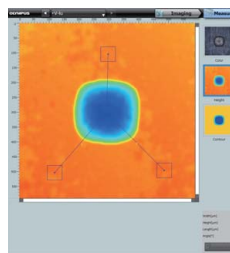

Step

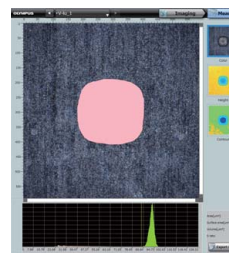

Area/Volume

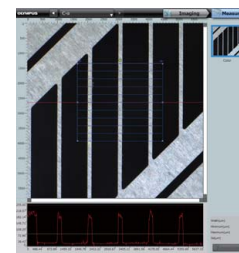

Caliper

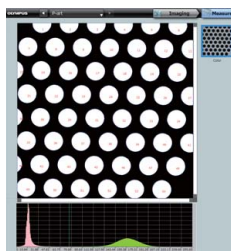

Particle

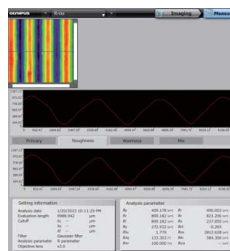

Line roughness

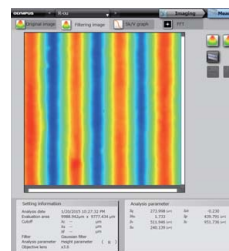

Surface roughness



Geometric

## Automatic Magnification Recognition

To reduce human error, DSX offers automatic magnification recognition, with a motorized zoom system so the system always knows what lens is being used. Changing lens magnification automatically changes the magnification setting, eliminating the opportunity for measurement error. When the zoom magnification is changed, the current magnification and image area information is also updated, further reducing errors in magnification indication and in measurement.

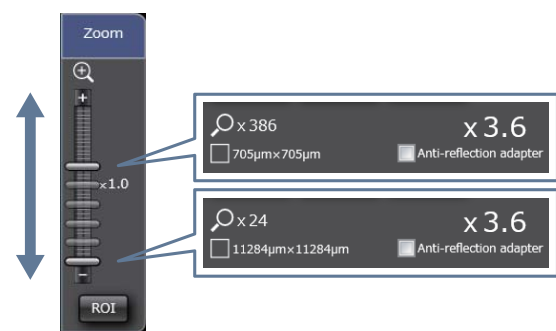



# Easy Sharing

Custom Reports. Easy to Create.



With the DSX110, it's one simple click and the report function is in motion, recording images and measurements and turning them into detailed custom reports. Perform the observation or measurement — the system automatically generates the needed reports. The DSX110 also allows easy sharing of these reports, with the option to export to a variety of convenient formats (rtf, PDF, Excel).

# 100% of All Data Can Be shared

## Build Reports from the Office

The DSX110 also offers free offline software which allows performing of measurements and building reports from the office.

## Custom Report Generation Made Easy

With the DSX110, it's easy. Operators concentrate on image capture, observation, and measurement, and the DSX110 automatically generates the relevant reports. Report templates are fully customizable.



A click can generate a report

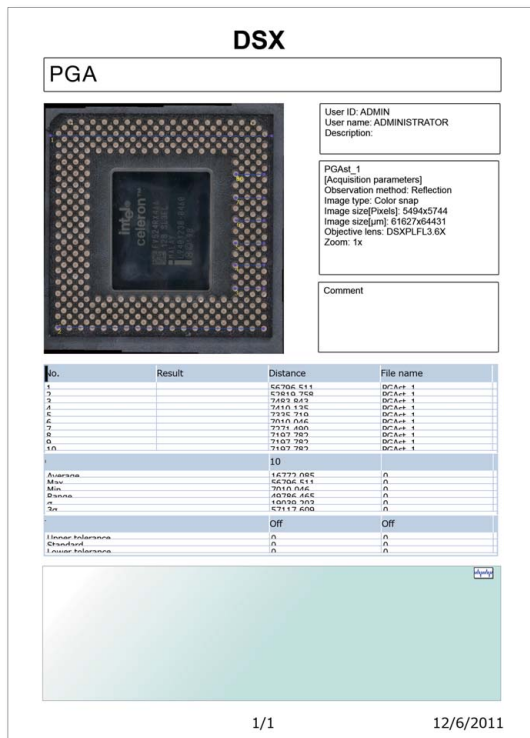

Report output

## Designates Printing Magnification from OLYMPUS Stream

Measurement results can be easily transferred to optional OLYMPUS Stream image analysis software, which offers advanced editable reporting. Stream reports can then be printed by specifying a scaling factor.

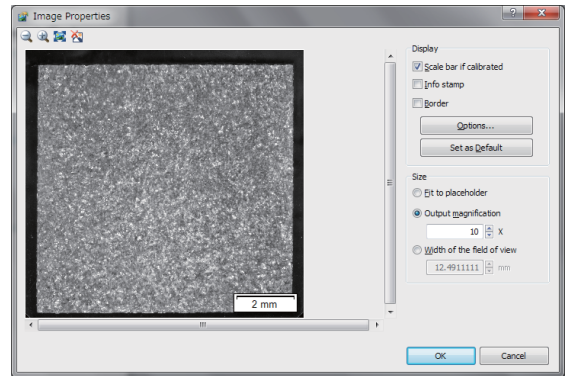

Magnification setting



Printing

# Applications

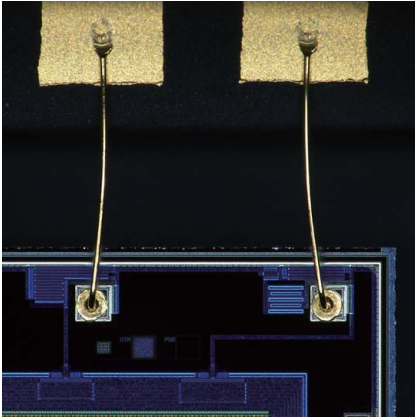

Bonding wire

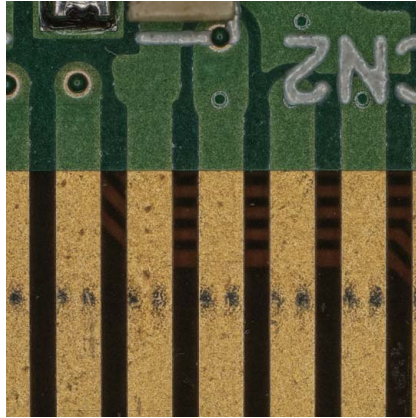

Multi-layer circuit board

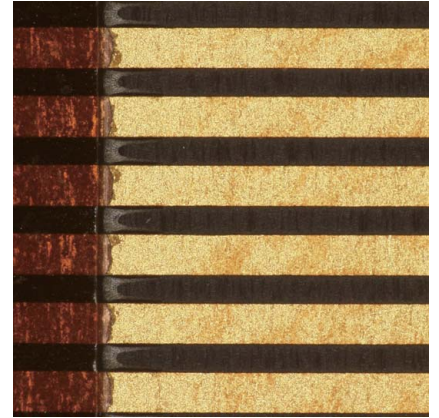

Flexible printed circuit board



Hard disk drive arm



PGA

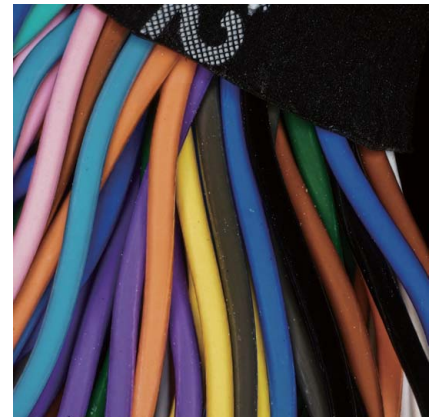

Cable



Pipe

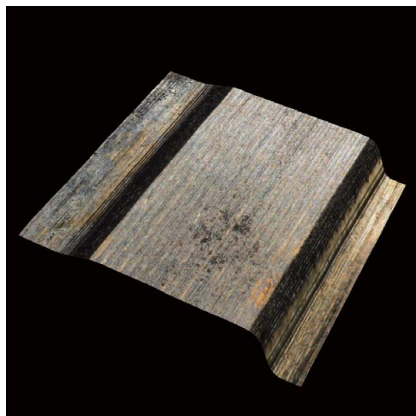

Metal component



Fractured metal surface



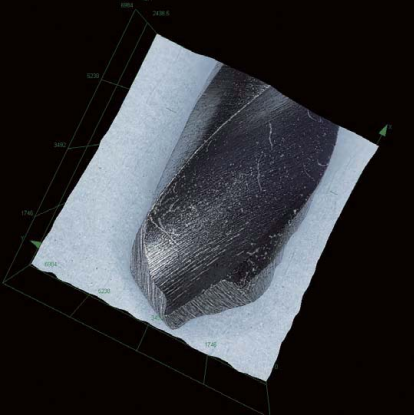

Tool

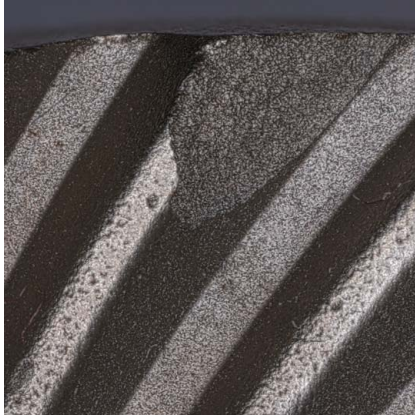

Gear

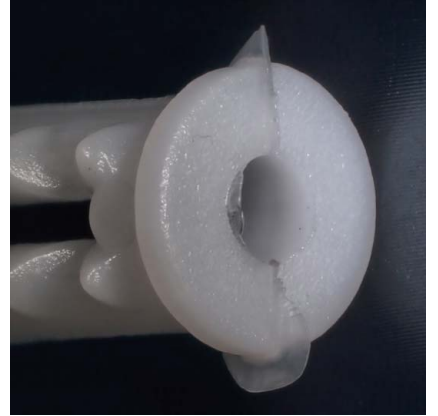

Injection molding resin



Fractured resin surface



Implant



Cloth



Tablet



Tablet



Food

# DSX110 System diagram

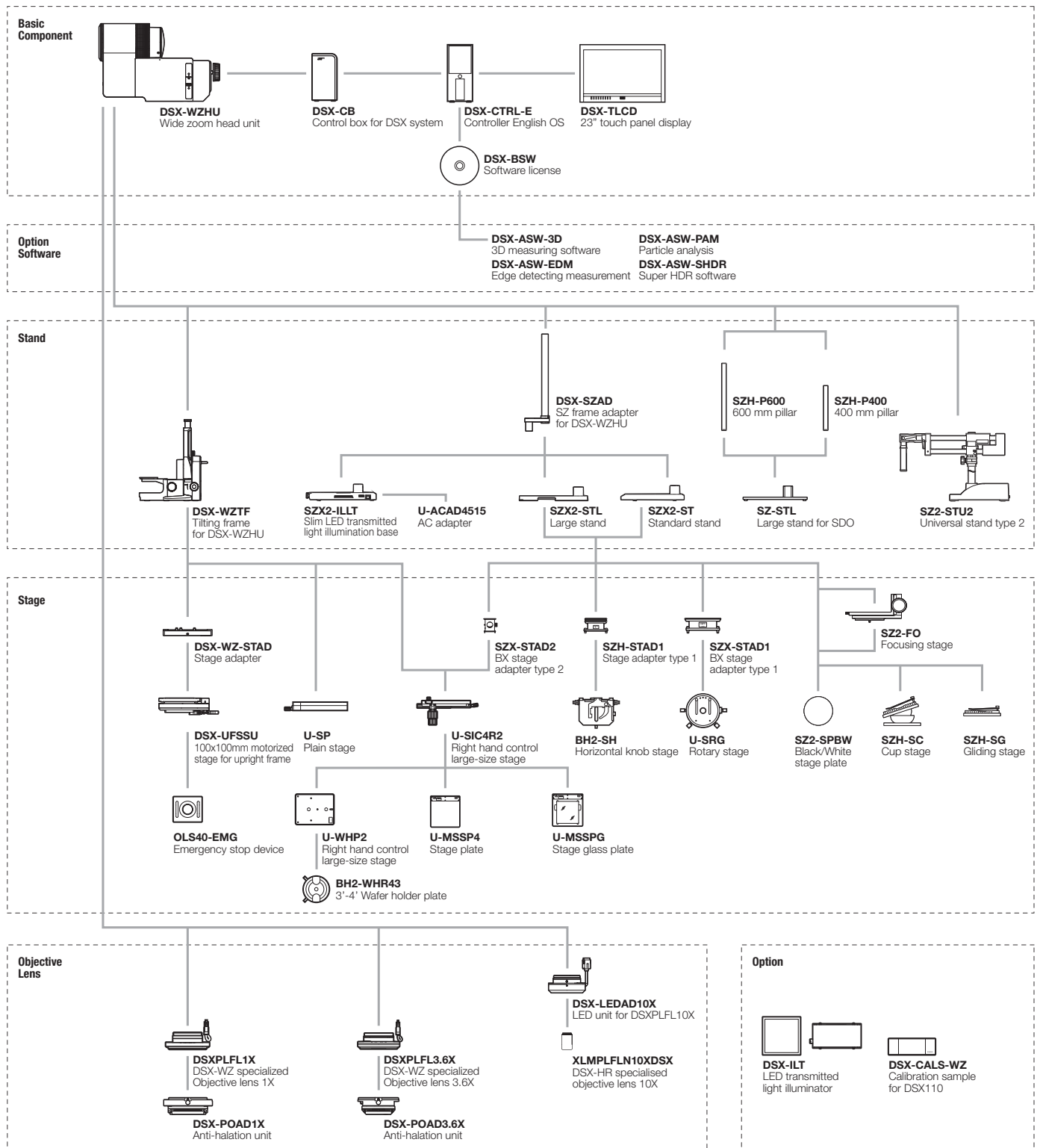

## DSX110 Dimensions

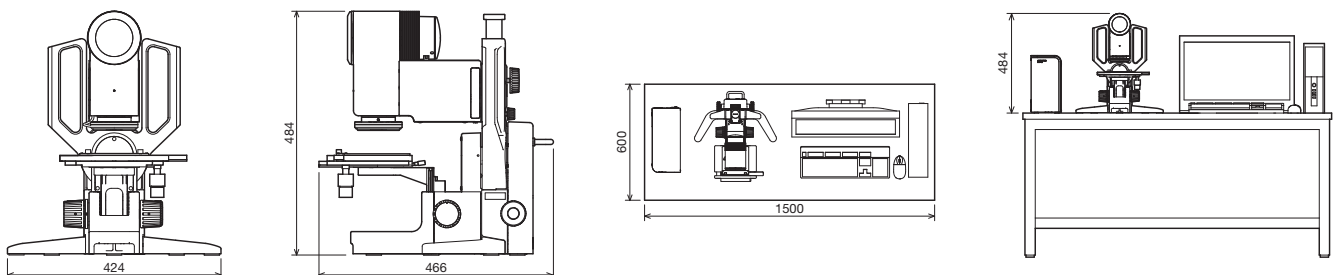

unit: mm

# DSX110 Specifications

Zoom ratio	Optical zoom	DSXPLFL3.6X/1X: 1X to 16X (max) XLMPLFLN10XDSX (with DSX-LEDAD10X): 4X to 16X (max)	
	Digital zoom	17X to 30X	
Mountable objective lens	DSX dedicated objective lens	DSXPLFL1X, DSXPLFL3.6X, XLMPLFLN10XDSX+DSX-LEDAD10X	
Illumination (Objective lens)		LED ring light illumination	
Main frame	Image sensor	1/1.8 inch, 2.01 megapixels, color CCD (total pixels: 2.10 megapixels) Total pixels : 1688 (H) x 1248 (V) Available pixels : 1628 (H) x 1236 (V) Effective pixels : 1600 (H) x 1200 (V)	
		Cooling method	Peltier cooling
	Camera	Scan mode	Progressive scan
		Frame rate	15 fps/27 fps with binning mode
		Image size	Normal : 1194 x 1194 (1:1)/1592 x 1194 (4:3) Fine : 1194 x 1194 (1:1)/1592 x 1194 (4:3) Super fine: 3594 x 3594 (1:1)/4792 x 3594 (4:3)
	Sensitivity	ISO 100/200/400/800/1600 equivalent	
	Fine focusing (Motorized)	Stroke	34 mm
		Resolution	0.4 μm
	Coarse focusing (Manual)	Stroke	50 mm
		Standard	80 mm*1
Frame	Maximum sample height	To ensure U-centric operation in tilted operation 50 mm*2	
	Tilt mechanism	Type	Manual, lock/release handle
		Tilt angle	Left/Right 45°
Stage	DSX-UFSSU (Motorized)*3	Stroke	100 x 100 mm
		Load capacity	1 kg
	U-SIC4R2 (Manual)	Stroke	100 x 105 mm
		Load capacity	1 kg
LCD monitor	Size	23" with touch panel and Full HD color LCD monitor	
	Resolution	1920 (H) x 1080 (V)	
Weight (Main frame, Manual stage, LCD monitor, Control box, Controller)		Approx. 36.5 kg	
Input rating		100-120 V/220-240 V, 300 V A, 50/60 Hz	

\*1 50 mm in case of the combination with DSX-UFSSU (not included BH2-WHR43/wafer holder plate) \*2 20 mm in case of the combination with DSX-UFSSU (not included BH2-WHR43/wafer holder plate)  
\*3 DSX-WZ-STAD is required to install

## DSX110 Objective Lens

Series	Model	Parfocalizing distance	NA	W.D. (mm)	Actual F.O.V. (μm)*1	Total magnification*2
DSX dedicated objective lens	DSXPLFL1X	167 mm	0.025	138*3	57,447-3,591	7X-107X
	DSXPLFL3.6X	79 mm	0.09	50*4	15,958-997	24X-386X
	XLMPLFLN10XDSX + DSX-LEDAD10X	79 mm	0.27	30	1,437-359	268X-1,071X

\*1 At aspect ratio 1:1 diagonal (with factory default value) \*2 At aspect ratio 1:1 \*3 123 mm in case of the combination with the DSX-POAD1X \*4 35 mm in case of the combination with the DSX-POAD3.6X



[www.olympus-ims.com](http://www.olympus-ims.com)

**OLYMPUS**<sup>®</sup>

For enquiries - contact  
[www.olympus-ims.com/contact-us](http://www.olympus-ims.com/contact-us)

**OLYMPUS CORPORATION**  
Shinjuku Monolith, 2-3-1 Nishi-Shinjuku, Shinjuku-ku, Tokyo 163-0914, Japan  
**OLYMPUS EUROPA SE & CO. KG**  
Wendenstrasse 14-18, 20097 Hamburg, Germany  
**OLYMPUS SCIENTIFIC SOLUTIONS AMERICAS CORP.**  
48 Woerd Avenue, Waltham, MA 02453, U.S.A.  
**OLYMPUS MEDICAL SYSTEMS INDIA PRIVATE LIMITED.**  
Ground Floor, Tower-C, SAS Tower, The Medicity Complex, Sector-38, Gurgaon 122001, Haryana, India

**OLYMPUS KOREA CO., LTD.**  
8F Olympus Tower, 446 Bongeunsa-ro, Gangnam-gu, Seoul, 06153 Korea  
**OLYMPUS SINGAPORE PTE LTD.**  
491B River Valley Road, #12-01/04 Valley Point Office Tower, Singapore 248373  
**OLYMPUS (CHINA) CO., LTD.**  
10F, K, Wah Centre, 1010 Huai Hai Road (M), Xuhai District, Shanghai, 200031 P.R.C.

- **OLYMPUS CORPORATION is ISO14001 certified.**
- **OLYMPUS CORPORATION is ISO9001 certified.**
- This product is designed for use in industrial environments for the EMC performance. Using it in a residential environment may affect other equipment in the environment.
- All company and product names are registered trademarks and/or trademarks of their respective owners.
- Images on the PC monitors are simulated.
- Specifications and appearances are subject to change without any notice or obligation on the part of the manufacturer.

N8600138-042016